

Ø150

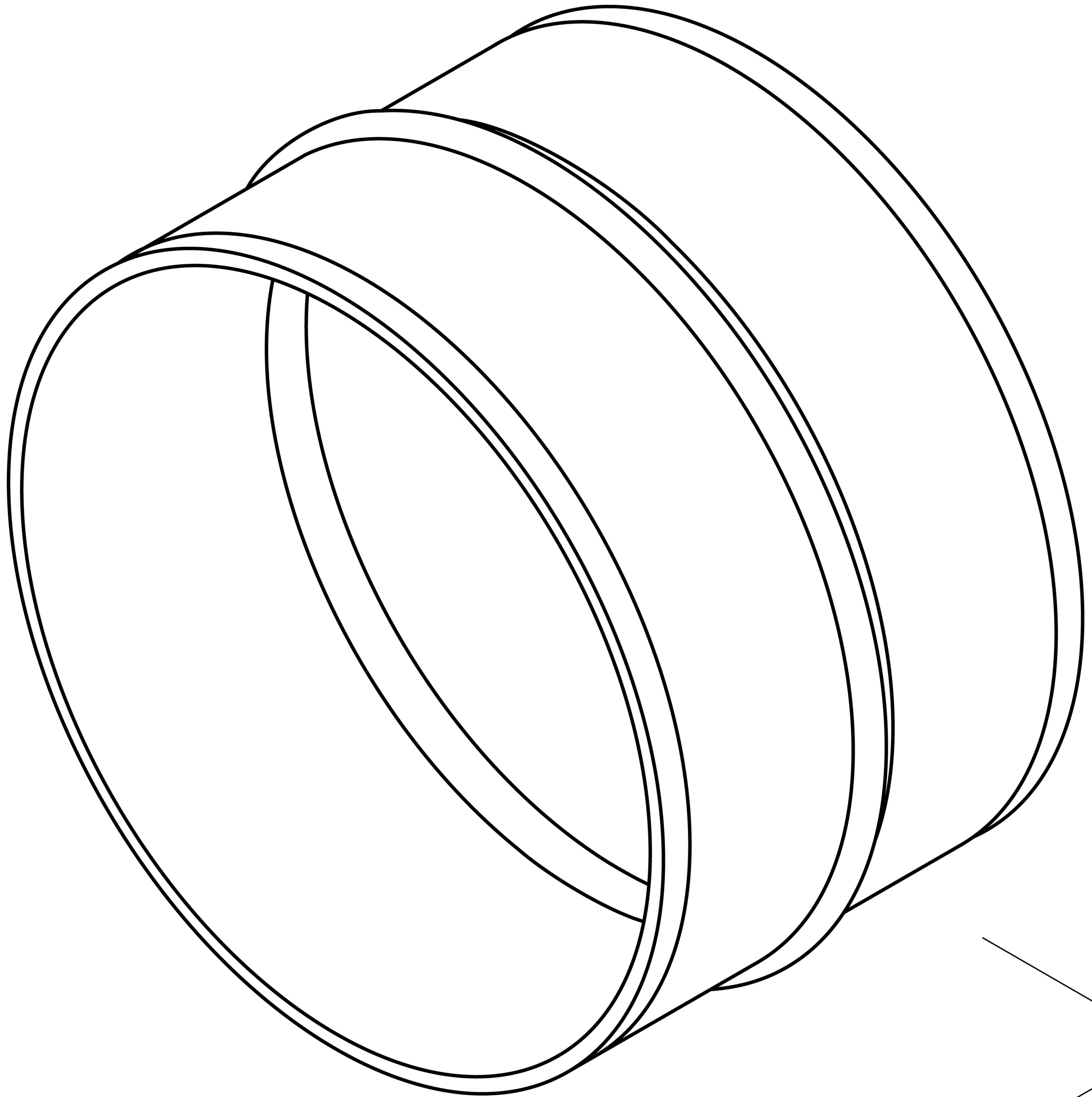

80